

02P

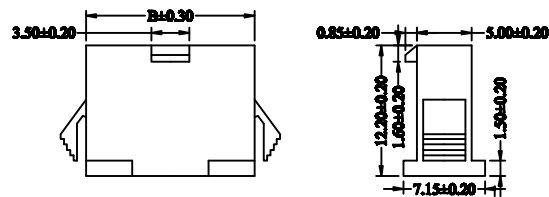

03P

■ SPECIFICATIONS

- Current rating: 3A AC/DC
- Voltage rating: 250V AC/DC
- Insulation resistance: 500MΩmin.
- Withstanding Voltage: 1500V AC/Minute.
- Temperature range: -25°C~+110°C
- Contact resistance: Initial Value/10mΩMax.
- After environmental testing/20mΩMax.

■ HOUSING

- Part No: J2510FH
- Poles: 02-12
- Material: Nylon 66 UL 94V-0
- Suitable HLB J2510MT series Terminal
- Mates with HLB J2510MH series Housing
- Q ty: 1000pcs/bag

Poles	Part No	Dimensions (mm)	
		A	B
2	J2510FH-02	2.50	5.50
3	J2510FH-03	5.00	8.00
4	J2510FH-04	7.50	10.50
5	J2510FH-05	10.00	13.00
6	J2510FH-06	12.50	15.50
7	J2510FH-07	15.00	18.00
8	J2510FH-08	17.50	20.50
9	J2510FH-09	20.00	23.00
10	J2510FH-10	22.50	25.50
11	J2510FH-11	25.00	28.00
12	J2510FH-12	27.50	30.50

							GENERAL TOLERANCE X ±0.30 XX ±0.20 XXX ±0.10				东莞市翰皓精密电子有限公司 Dongguan HanHao Precision Electronics Co.,Ltd				PART NO. J2510FH-XX				
				Modify frame format			Jova	Jova Lau	APPROVAL Smark				CHECK Yu wei						
				DESCRIPTION			CHECK	APPROVAL	DRAWN Liu Yan				DATA 2011/05/22						
2011/05/22 DATE				A OLD REV		B NEW REV		ECN		UNIT mm				SCALE 1:1		NUMBER 8		REV B	

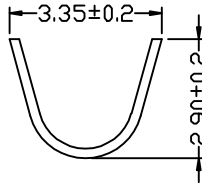
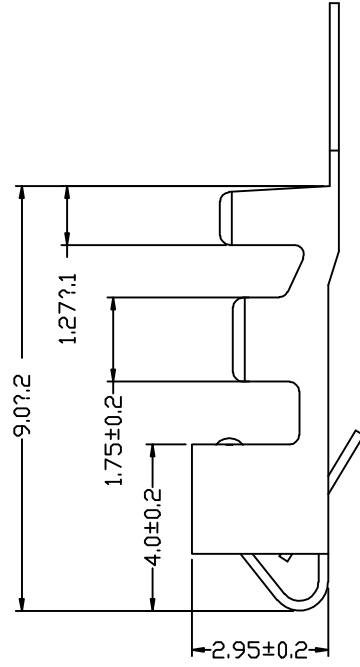
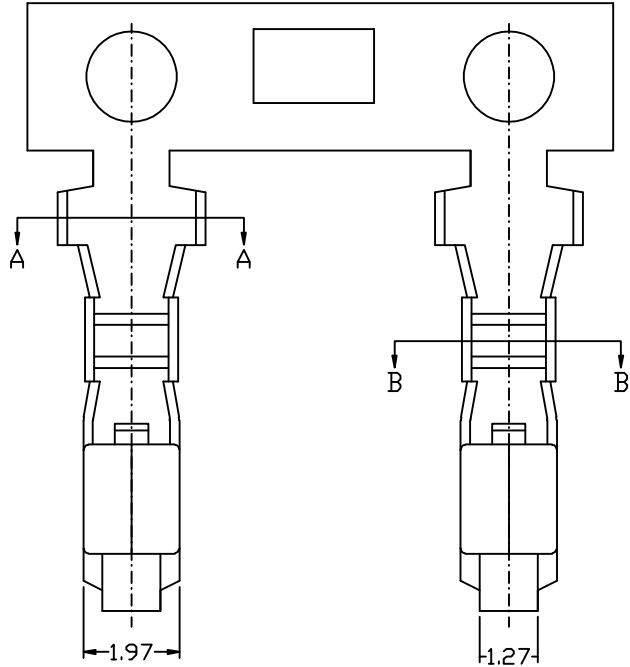

Section: A-A

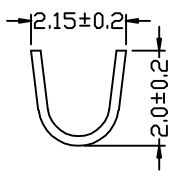

Section: B-B

■ SPECIFICATIONS

- Voltage Rating: 250V AC, DC
- Current Rating: 3A, AC/DC
- Withstanding Voltage: 1500V AC/minute
- Insulation Resistance: 500MΩmin
- Temperature Range: -25°C~+85°C
- Contact resistance: Intial value/10mΩmax
- After enviromental testing/20mΩmax

■ TERMINAL

- Part No.: J2510MT
- Applicable Wire: AWG#22-28
- Material: Brass
- Q'ty: 10000 pcs/reel

							GENERAL TOLERANCE X ±0.30 XX ±0.20 XXX ±0.10				东莞市翰皓精密电子有限公司 Dongguan HanHao Precision Electronics Co.,Ltd				PART NO. J2510MT			
											TITLE 2.5 mm Crimp Style Connectors							
2011/05/22	A	B		Modify frame format	Jova	Jova Lau				APPROVAL	CHECK	DRAWN	DATA					
DATE	OLD REV	NEW REV	ECN	DESCRIPTION	CHECK	APPROVAL	PROJECT			Smak	Yu wei	Liu Yan	2011/05/22	UNIT	SCALE	NUMBER	REV	
1														mm	1:1	8	B	

1 | 2 | 3 | 4 | 5 | 6 | 7 | 8

F
E
D
C
B
A

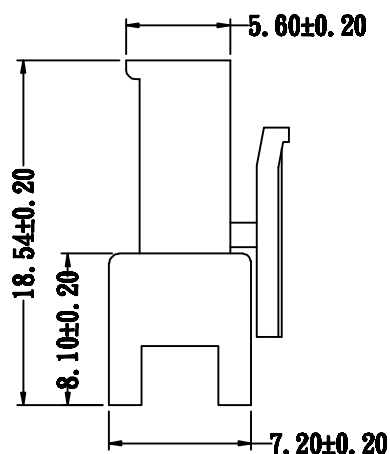
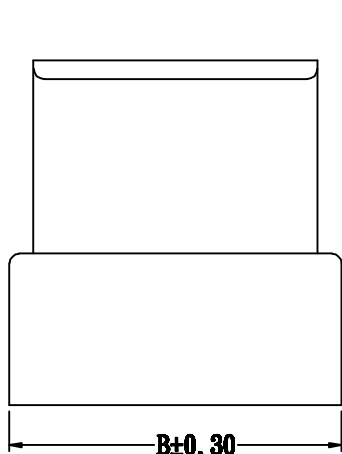
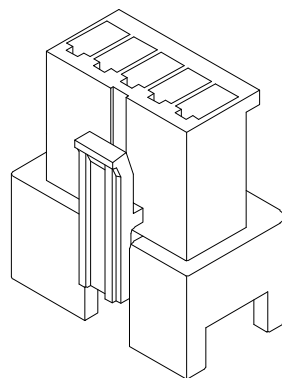
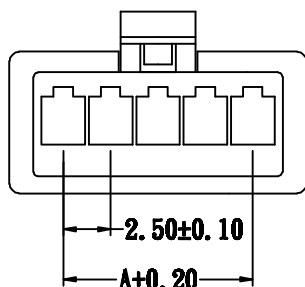

■ SPECIFICATIONS

- Current rating: 3A AC/DC
- Voltage rating: 250V AC/DC
- Temperature range: -25°C~+110°C
- Insulation resistance: 500M ΩMin.
- Withstanding Voltage: 1500V AC/Minute.
- Contact resistance: Initial Value/10m ΩMax.
- After environmental testing/20m ΩMax.

■ HOUSING

- Part No: J2510MH-XX
- Poles: 02-12
- Material: Nylon 66 UL 94V-0
- Suitable HLB J2510FT series Terminal
- Mates with HLB J2510FH series Housing
- Q ty: 1000pcs/bag

Poles	Part No	Dimensions (mm)	
		A	B
2	J2510MH-02	2.50	7.95
3	J2510MH-03	5.00	10.45
4	J2510MH-04	7.50	12.95
5	J2510MH-05	10.00	15.45
6	J2510MH-06	12.50	17.95
7	J2510MH-07	15.00	20.45
8	J2510MH-08	17.50	22.95
9	J2510MH-09	20.00	25.45
10	J2510MH-10	22.50	27.95
11	J2510MH-11	25.00	30.45
12	J2510MH-12	27.50	32.95

							GENERAL TOLERANCE X ±0.30 XX ±0.20 XXX ±0.10				东莞市翰皓精密电子有限公司 Dongguan HanHao Precision Electronics Co.,Ltd				PART NO. J2510MH-XX							
											TITLE 2.5 mm Crimp Style Connectors											
							APPROVAL Smark		CHECK Yu wei		DRAWN Liu Yan		DATA 2011/05/22		UNIT mm		SCALE 1:1		NUMBER 8		REV B	
2011/05/22	A	B	/	Modify frame format	Jove	Jove Lau																
DATE	OLD REV	NEW REV	ECN	DESCRIPTION	CHECK	APPROVAL	PROJECT															

1 | 2 | 3 | 4 | 5 | 6 | 7 | 8

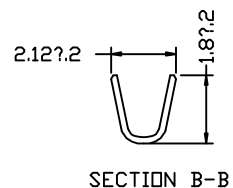
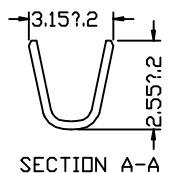
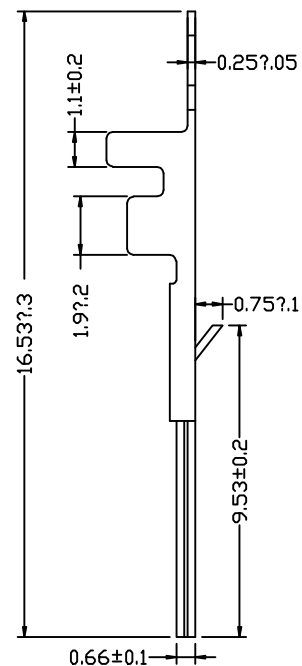
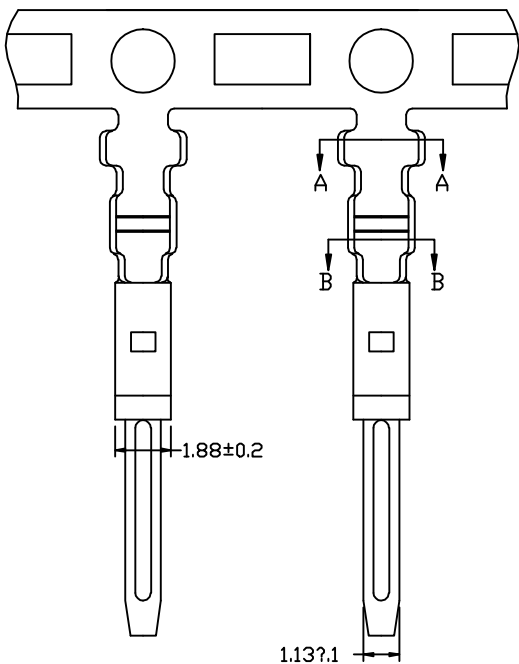

■ SPECIFICATIONS

- Voltage rating: 250V AC, DC
- Current rating: 3A, AC, DC
- Withstanding Voltage: 1500V AC/minute
- Insulation resistance: 500M Ωmin
- Temperature range: -25 C~+85 C
- (Including temperature rise in applying electrical current)
- Applicable PC board thickness: 0.063" (1.6mm)
- Contact resistance: Initial Value/10m Ωmax After environmental testing/20m Ωmax

☐ TERMINAL

- Part No.: M2510FT
- Applicable wires: AWG#22-28
- Material: Phosphor Bronze
- Finish: Tin plated
- Used in HLB J2510FT series Housing
- Q'ty: 9000 pcs/reel

							GENERAL TOLERANCE X ±0.30 XX ±0.20 XXX ±0.10				东莞市翰皓精密电子有限公司 Dongguan HanHao Precision Electronics Co.,Ltd				PART NO. J2510FT			
											TITLE 2.5 mm Crimp Style Connectors							
2011/05/22	A	B		Modify frame format	Jova	Jova Lau	APPROVAL	CHECK	DRAWN	DATA	UNIT	SCALE	NUMBER	REV				
DATE	OLD REV	NEW REV	ECN	DESCRIPTION	CHECK	APPROVAL	Smark	Yu wei	Liu Yan	2011/05/22	mm	1:1	8	B				