

**Specifications**

- Voltage rating: 1400V AC, DC
- Current rating: 1A, AC, DC
- Withstanding Voltage: 3800V AC/minute
- Insulation resistance: 1000MΩmin
- Temperature range: -25°C~+85°C
- Contact resistance: Initial value/10mΩmax
- After environmental testing/20mΩmax

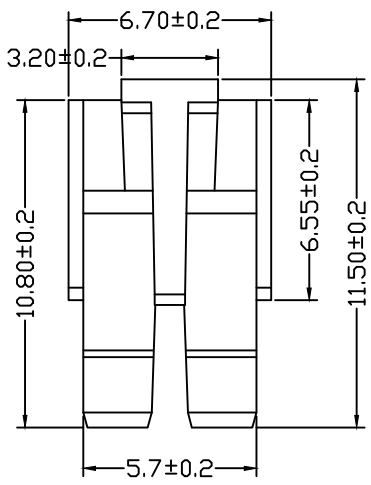
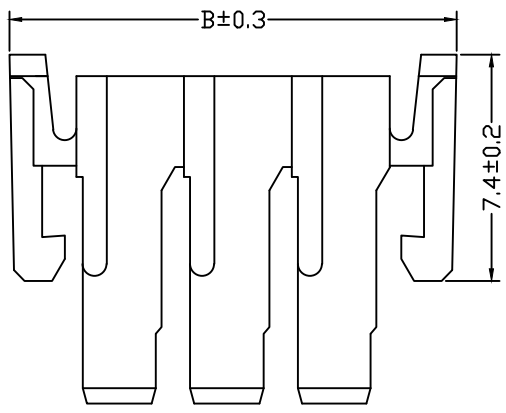

**Housing**

- Part No.: J3500FHA
- Poles: 06、12
- Material: Nylon 66 UL94V-0
- Suitable HLB J3500T series Terminal
- Mates with HLB J3500 series dual row Housing
- Q'ty: 1000pcs/bag

Poles	Part No	Dimensions (mm)	
		A	B
6	J3500FHA-06	7.00	14.45
12	J3500FHA-12	17.50	24.50

				GENERAL TOLERANCE			东莞市翰皓精密电子有限公司 Dongguan HanHao Precision Electronics Co.,Ltd				PART NO. J3500FHA-2*XX				
				.X ±0.30			APPROVAL				TITLE 3.5 mm Crimp Style Connectors				
				.XX ±0.20			CHECK				SCALE 1:				
				.XXX ±0.10			DRAWN				NUMBER				
2011/05/22	A	B	/	Modify frame format	Jova	Jova Lau	DATA				REV B				
DATE	OLD REV	NEW REV	ECN	DESCRIPTION	CHECK	APPROVAL	PROJECT	Smark	Yu wei	Liu Yan	2011/05/22	UNIT mm	SCALE 1:	NUMBER	REV B

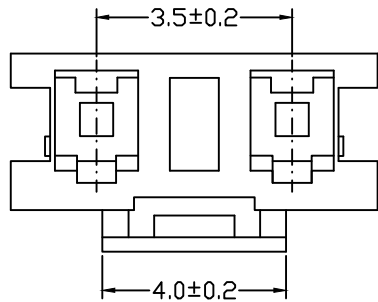

■ Specifications

- Voltage rating: 1400V AC, DC
- Current rating: 1A, AC, DC
- Withstanding Voltage: 3800V AC/minute
- Insulation resistance: 1000MΩmin
- Temperature range: -25°C~+85°C
- Contact resistance: Intial value/10mΩmax
- After enviornment testing/20mΩmax

■ Housing

- Part No.: J3500FHA
- Poles: 02
- Material: Nylon 66 UL94V-0
- Q'ty: 1000pcs/bag

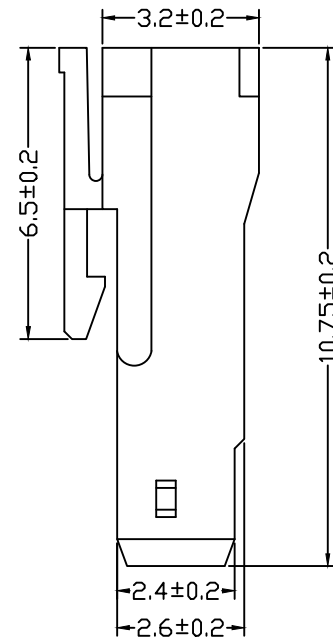
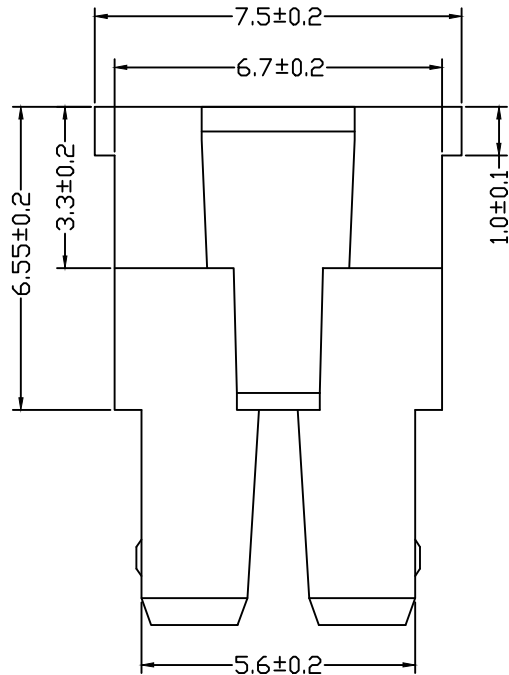

							GENERAL TOLERANCE	东莞市翰皓精密电子有限公司 Dongguan HanHao Precision Electronics Co.,Ltd				PART NO. J3500FHA-02							
							.X ±0.30	APPROVAL				TITLE 3.5 mm Crimp Style Connectors							
							.XX ±0.20					CHECK				DRAWN			
							.XXX ±0.10					DATA				REV			
2011/05/22	A	B	/	Modify frame format	Jova	Jova Lau	PROJECT	Smark	Yu wei	Liu Yan	2011/05/22	UNIT	SCALE	NUMBER	REV				
DATE	OLD REV	NEW REV		ECN	DESCRIPTION	CHECK	APPROVAL	PROJECT					mm	1:		B			

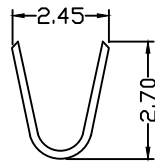
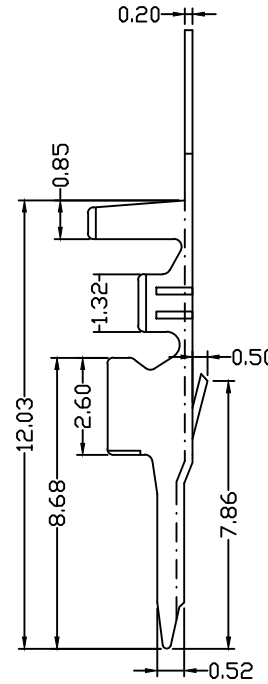
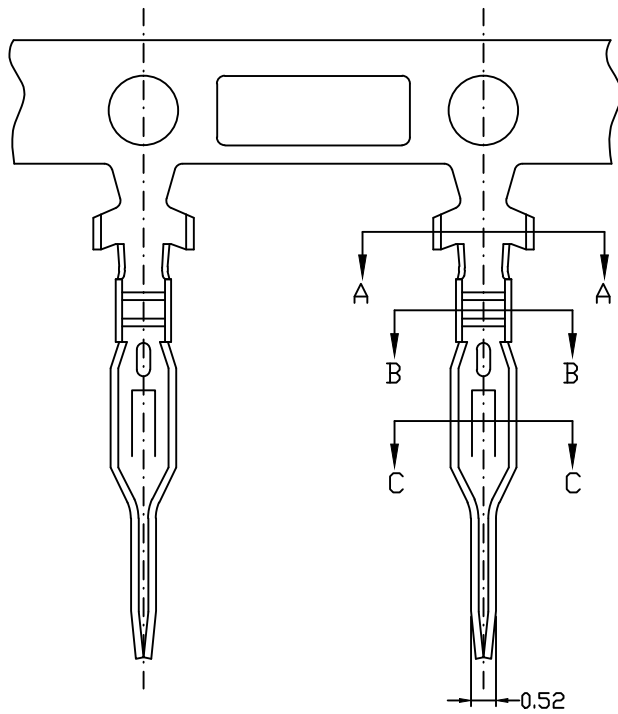

A-A SEC

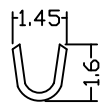

B-B SEC

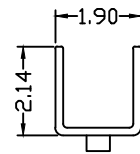

C-C SEC

■ Specifications

- Voltage rating : 1,400V AC, DC
- Current rating : 1A AC,DC
- Withstanding voltage : 3,800V AC/minute
- Insulation resistance : 1,000MΩ min
- Temperature range : - 25°C to + 85°C
- (Including temperature rise in applying electrical current)
- Contact resistance : Initial value/10mΩ max  
After environmental testing/20mΩ max

■ Housing

- Part No :J3500FT
- Poles : 02
- Material : Nylon 66 UL94V-0
- Used in HLB J3500 series Housing
- Q'ty : 1,000 pcs/bag

							GENERAL TOLERANCE		东莞市翰皓精密电子有限公司 Dongguan HanHao Precision Electronics Co.,Ltd				PART NO. J3500FT			
							.X ±0.30		APPROVAL				TITLE 3.5 mm Crimp Style Connectors			
							.XX ±0.20		Smak				Yu wei			
							.XXX ±0.10		DRAWN				Liu Yan			
							PROJECT		2011/05/22				DATA			
DATE	OLD REV	NEW REV	ECN	DESCRIPTION	CHECK	APPROVAL	PROJECT		UNIT	SCALE	NUMBER	REV				
2011/05/22	A	B		Modify frame format	Jova	Jova Lau	PROJECT		mm	1:	8	B				



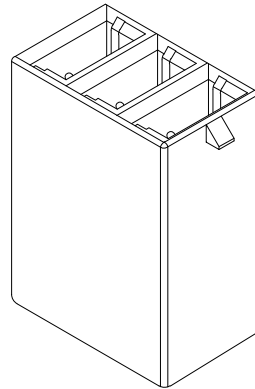
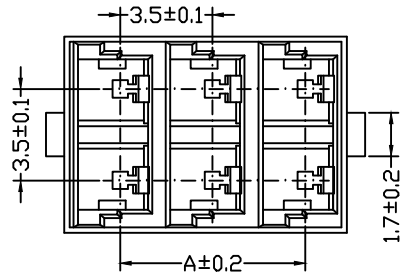

**■ SPECIFICATIONS**

- Voltage rating: 1400V AC, DC
- Current rating: 1A, AC, DC
- Withstanding Voltage: 3800V AC/minute
- Insulation resistance: 1000MΩmin
- Temperature range: -25°C~+85°C
- Contact resistance: Intial value/10mΩmax
- After enviornmental testing/20mΩmax

**■ HOUSING**

- Part No.: J3500MHA
- Poles: 06、12
- Material: Nylon 66 UL94V-0
- Suitable HLB J3500T series Terminal
- Mates with HLB J3500 series dual row Housing
- Q'ty: 1000pcs/bag

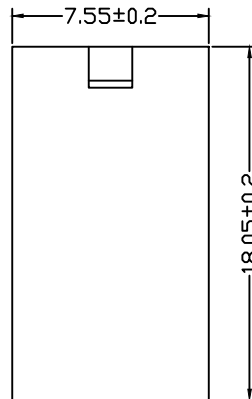
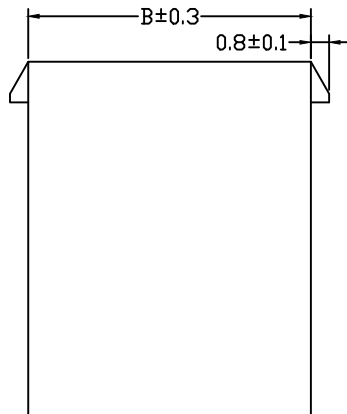

Poles	Part No	Dimensions (mm)	
		A	B
6	J3500MHA-06	7.00	14.45
12	J3500MHA-12	17.50	24.50

				GENERAL TOLERANCE		东莞市翰皓精密电子有限公司 Dongguan HanHao Precision Electronics Co.,Ltd				PART NO. J3500MHA-2*XX				
				.X ±0.30		APPROVAL				TITLE 3.5 mm Crimp Style Connectors				
				.XX ±0.20		CHECK								
				.XXX ±0.10		DRAWN								
				PROJECT		DATA								
DATE	OLD REV	NEW REV	ECN	DESCRIPTION	CHECK	APPROVAL	Smark	Yu wei	Liu Yan	2011/05/22	UNIT mm	SCALE 1:	NUMBER 8	REV B

2011/05/22

A

B

Modify frame format

Jova

Jova Lau

APPROVAL

CHECK

DRAWN

DATA

Smark

Yu wei

Liu Yan

2011/05/22

UNIT

SCALE

NUMBER

REV

mm

1:

8

B

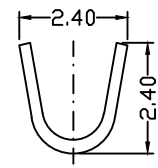
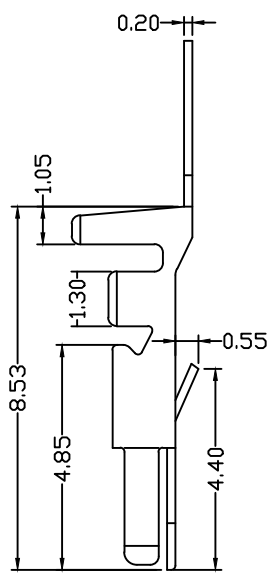
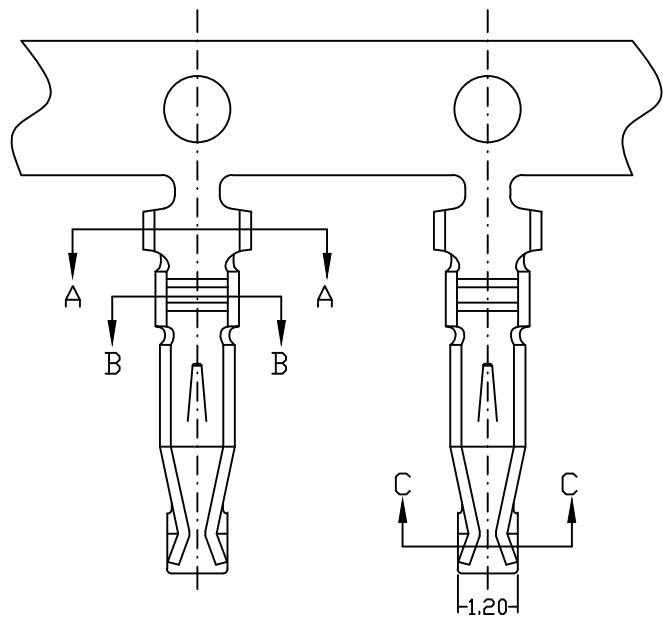

A-A SEC

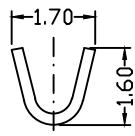

B-B SEC

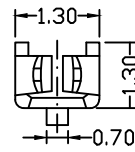

C-C SEC

■ Specifications

- Voltage rating : 1,400V AC, DC
- Current rating : 1A AC,DC
- Withstanding voltage : 3,800V AC/minute
- Insulation resistance : 1,000MΩ min
- Temperature range : - 25°C to + 85°C
- (Including temperature rise in applying electrical current)
- Contact resistance : Initial value/10mΩ max  
After environmental testing/20mΩ max

■ Housing

- Part No : J3500MT
- Poles : 02
- Material : Phosphor Bronze
- Finish: Tin-plated
- Used in HLB J3500 series Housing
- Q'ty : 1000 pcs/bag

CONTACT INFORMATION

Part No	Wire Range	Insulation O.D.	Material	Finish	Qty/reel
J3500MT	AWG #24-#28	1.60mm(MAX.)	Phosphor brone	Tin-Plated	9000 pcs

							GENERAL TOLERANCE .X ±0.30 .XX ±0.20 .XXX ±0.10				东莞市翰皓精密电子有限公司 Dongguan HanHao Precision Electronics Co.,Ltd				PART NO. J3500MT			
							APPROVAL    CHECK    DRAWN    DATA				TITLE 3.5 mm Crimp Style Connectors							
DATE	OLD REV	NEW REV	ECN	DESCRIPTION	CHECK	APPROVAL	PROJECT	Smark	Yu wei	Liu Yan	2011/05/22	UNIT	SCALE	NUMBER	REV			
2011/05/22	A	B		Modify frame format	Jova	Jova Lau						mm	1:	8	B			

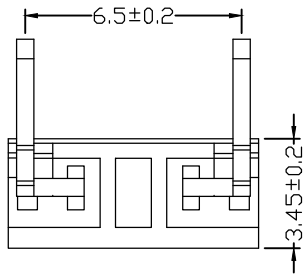
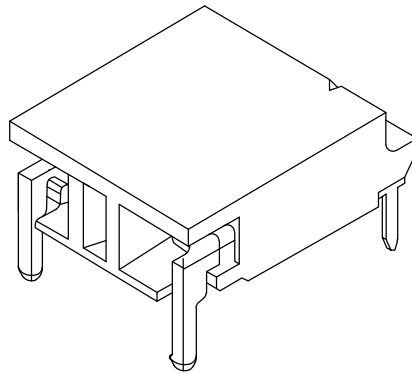
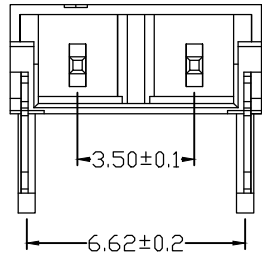

■ Specifications

- Electrical
- Current Rating: 1A AC, DC
- Voltage Rating: 1400V AC, DC
- Operating Temp.: -25°C ~ +85°C
- Insulation Resistance: 1000MΩ/ min.
- Dielectric Withstanding Voltage: 3800V AC/ min.
- Contact Resistance: 10mΩ/ max.

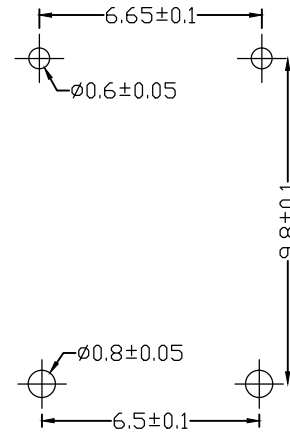
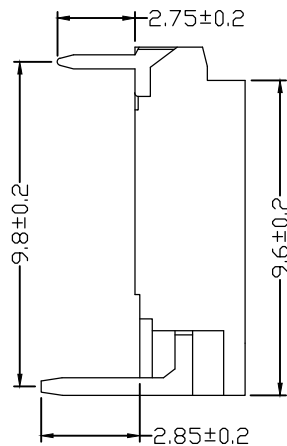
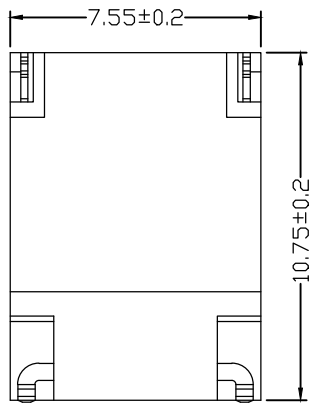

Recommened PCB Layout

■ Material

- Material: Pin: Brass/Tin-plated
- Material: Nylon6T, UL94V-0
- Mates with HLB J3500 series Housing

							GENERAL TOLERANCE		东莞市翰皓精密电子有限公司				PART NO. J3500WR-02			
							.X ±0.30		Dongguan HanHao Precision Electronics Co.,Ltd				TITLE 3.5 mm Crimp Style Connectors			
							.XX ±0.20		APPROVAL		CHECK		DRAWN		DATA	
							.XXX ±0.10		Smark		Yu wei		Liu Yan		2011/05/22	
							PROJECT		UNIT mm		SCALE 1:		NUMBER 8		REV B	
2011/05/22	A	B		Modify frame format	Jova	Jova Lau										
DATE	OLD REV	NEW REV	ECN	DESCRIPTION	CHECK	APPROVAL										



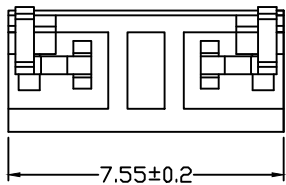
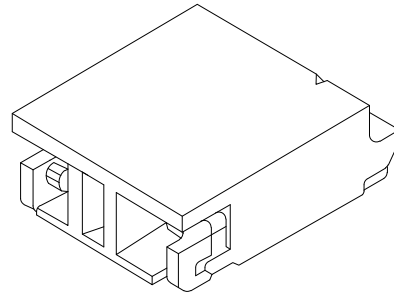
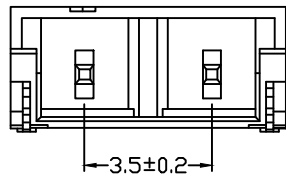

**■ SPECIFICATIONS**

- Voltage rating : 1,400V AC, DC
- Current rating : 1A AC,DC.
- Withstanding voltage : 3,800V AC/minute
- Insulation resistance : 1,000MΩ min.
- Temperature range : - 25℃ to + 85℃  
(Including temperature rise in applying lectrical current)
- Contact resistance : Initial value/10mΩ max.
- After environmental testing/20mΩ max.

**■ WAFER**

- Part No. : J3500WRS
- Poles : 02
- Material : Contact : Phos. Bronze, Tin plated
- Mates with HLB J3500 series Housing
- Base : Nylon PA46 UL94V-0

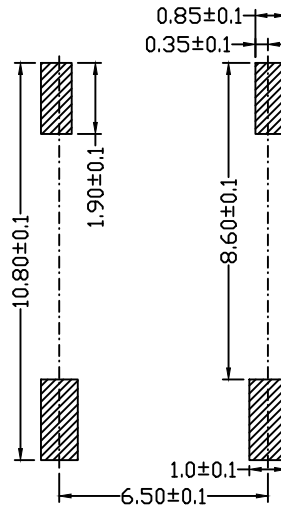
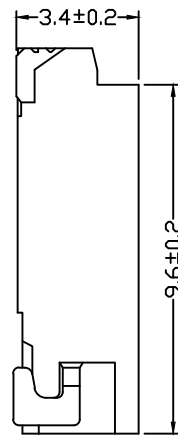
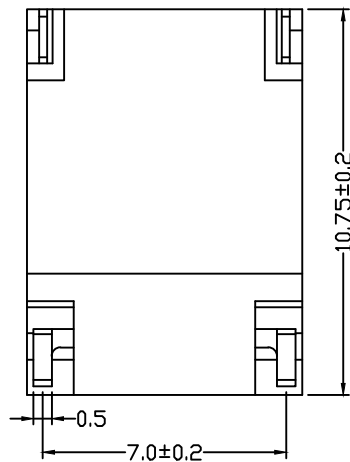

Recommand PCB Layout

							GENERAL TOLERANCE		东莞市翰皓精密电子有限公司 Dongguan HanHao Precision Electronics Co.,Ltd				PART NO. J3500WRS-02			
							.X ±0.30		APPROVAL				TITLE 3.5 mm Crimp Style Connectors			
							.XX ±0.20		Smak		Yu wei		Liu Yan		2011/05/22	
							.XXX ±0.10		PROJECT		UNIT		SCALE		NUMBER	
2011/05/22	A	B		Modify frame format	Jova	Jova Lau	PROJECT		mm		1:		8		REV B	
DATE	OLD REV	NEW REV	ECN	DESCRIPTION	CHECK	APPROVAL	PROJECT		UNIT		SCALE		NUMBER		REV	